

Touch the future of scale technology.

ISHIDA

Retail Scale Register

Uni-7

4 Do you want to increase your sales through cross merchandising?

The compact, low-profile UNI-7 uses a front cassette loading method, freeing up more counter space for displaying related products and making it easier to replace labels. Cross merchandising becomes more effective when using coupon labels.

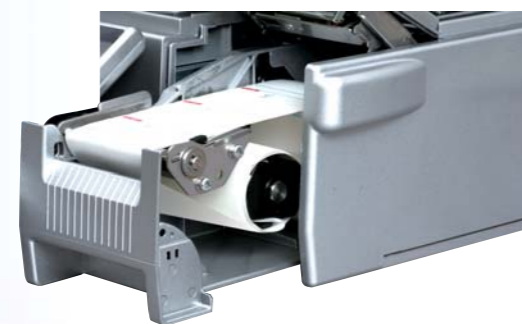

5 Do operators and customers with various ethnic backgrounds require you to use multiple languages?

With the UNI-7, you can pre-select one of five languages listed on the selection screen. In the parameter settings, you can also select two languages to be printed at the same time, providing your customers with easy-to-follow displays and printing. The UNI-7 offers universal functions for increasing target customers and supporting global deployment.

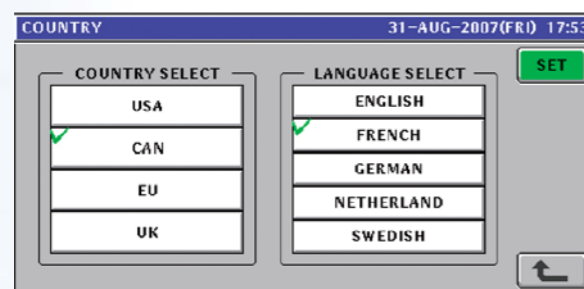

6

Are you looking for new ideas to differentiate your stores from those of your competitors?

You can pull in more customers by inviting popular tenants or setting up stimulating store environments, because the UNI-7 can issue receipts as well as labels. With a quick automatic cutter (available for the elevator type) equipped with a receipt fall prevention function, the UNI-7 supports your speedy operations.



7 Are you looking for an appealing method for visualizing food safety and security?

The UNI-7 memory can be expanded up to 2GB, allowing you to appeal to your customers with visual information such as logos, messages, and data on traceability, ingredients and nutrition, which will be printed on labels. The UNI-7 is a tool that strengthens the credibility of your stores.

Note: Further information for GS1 barcode;
<http://www.gs1.org/productssolutions/barcodes/databar/>



ISHIDA

ISHIDA CO., LTD. www.ishida.com

44,SANNO-CHO, SHOGOIN SAKYO-KU,
 KYOTO 606-8392 JAPAN
 Phone : 81-75-771-4141 Facsimile : 81-75-751-1634

Yes, we are...
UNIVERSAL.

Across the seven seas.



Seven Questions & Answers

1 Do you need effective advertising that attracts the eyes of customers from a distance?

The UNI-7 is equipped with a high-quality color LCD. The repeated display of a wide range of advertising screens on the UNI-7 stimulates the customer's willingness to buy, so you can expect an increase in sales.



2 Do you want to maximize the use of your store operation system?

The Uni-7 can be equipped with a browser function. When using a Host System, this function allows data such as recipes and allergy information to be downloaded from the Web. The Uni-7 can also print out the information, enabling you to provide advanced consumer services. An e-mail function is also available, allowing orders to be placed directly from your store to the warehouse or production site.

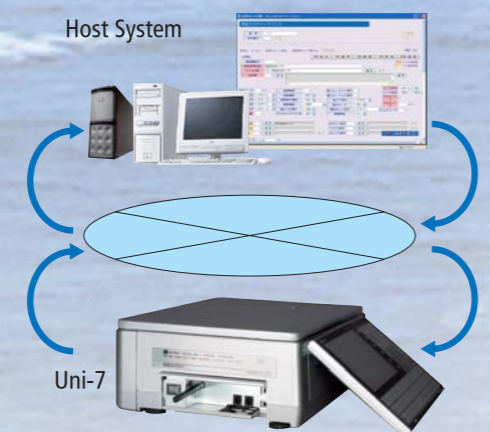

3 Do you often make input errors because it is difficult to hear the key entry sounds?

The UNI-7 is equipped with the industry's first vibration function, which provides clear tactile feedback to your fingertips with each key entry. Your quicker response time will reduce customer wait time.



* The images on the screens are composite photographs.

Seven Applications



Bench type

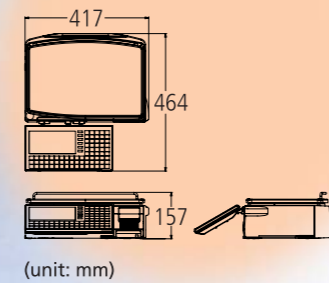

Pole type

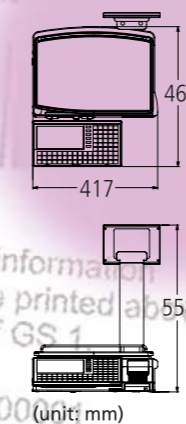

Self-service type

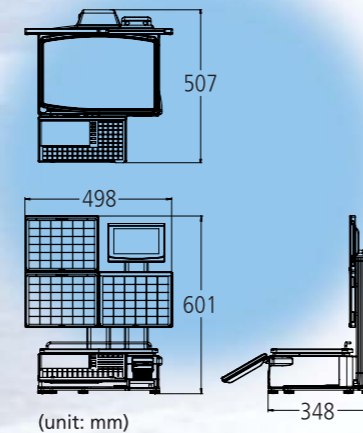

Elevator type twin printer

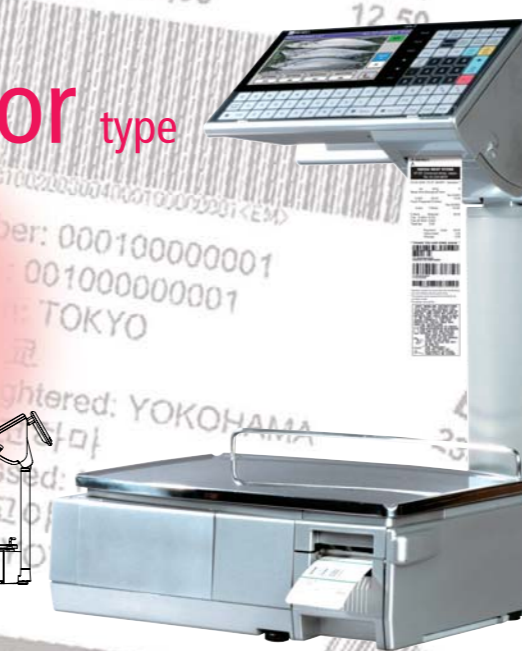
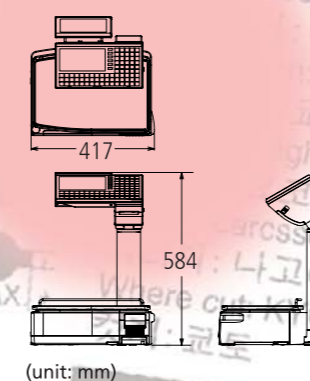

Bakery type

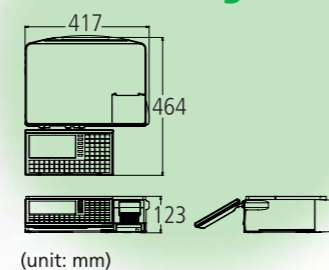

Elevator type single printer

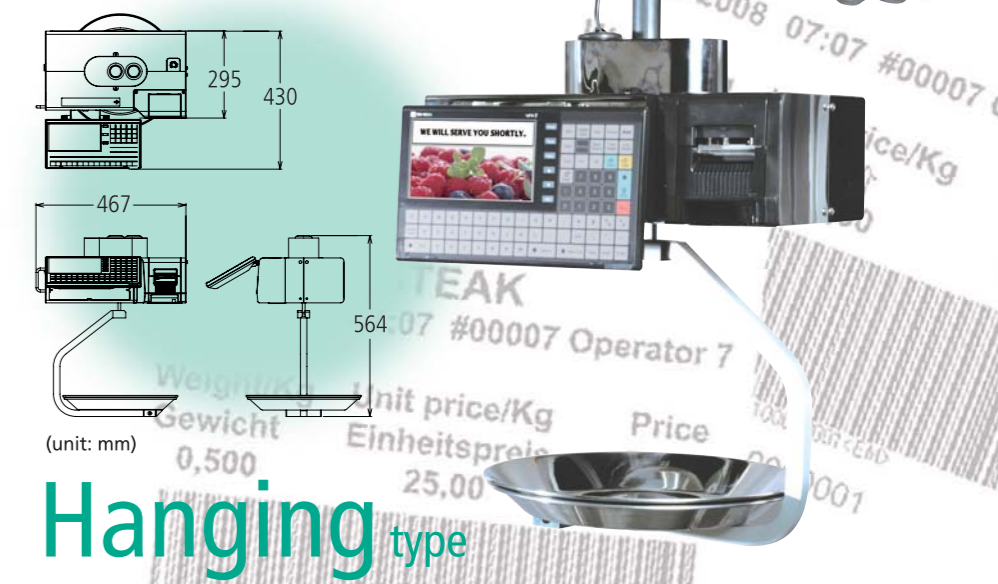

Hanging type

Specifications

| Items | Descriptions |
|---------------------------|--|
| Weighing capacity | 15 kg: 0 - 6 / 0.002 kg, 6 - 15 / 0.005 kg 30 lb: 0 - 15 / 0.005 lb, 15 - 30 / 0.010 lb |
| Weighing accuracy | 1/3000 |
| Power supply | AC100 - 240V, 50 / 60 Hz |
| Power consumption | 1.0A/0.5 A |
| Operator/Customer display | 7-inch color liquid crystal with backlight |
| Keypad | 84 keys (Dextersy keys) |
| Printing method | Direct thermal |
| Thermal head | 2 inches and 8 dots/mm |
| Printing speed | MAX 120 mm/second |
| Label size | Width: 30 mm to 60 mm Length: 20 mm to 150 mm |
| Number of cassettes | 7 cassettes (front-loading type) |
| Roll size | Outer diameter: ø100mm or less Inner diameter: ø40mm ±1mm |
| Weight | Bench type: Approx.11.5 kg Pole type: Approx.12.5 kg |
| Use conditions | Temperature: -5 to 40 °C Humidity: 20 to 85% No condensation |
| Input/Output | LAN x 1 (Wireless: Optional) USB x 1 CF x 1 Drawer x 2 |